

OPERATION MANUAL
SPECTRUM ANALYZER
MS610A

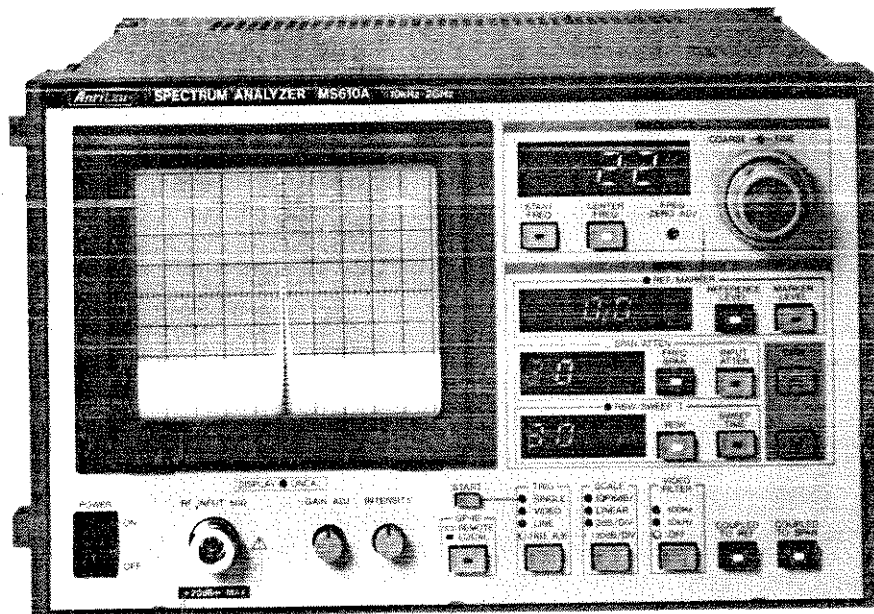

ANRITSU ELECTRIC CO., LTD.

CERTIFICATION

Anritsu Electric Co., Ltd. certifies that this instrument has been thoroughly tested and inspected, and found to meet published specifications prior to shipping.

Anritsu further certifies that its calibration measurements are based on the Japanese Electrotechnical Laboratory and Radio Research Laboratory standards.

WARRANTY

All Anritsu products are warranted against defects in material and workmanship. The warranty is effective for one year from the date of delivery. In the event of improper use, abuse, or damage due to natural catastrophe, the warranty will become void. Anritsu will repair or replace products which prove to be defective during the warranty period, provided they are returned to Anritsu.

No other warranty is expressed or implied.

All requests for repairs and replacement parts should be directed to Anritsu or its representative in your area.

N O T E

- (1) The instrument is operable on a nominal voltage of 100 to 127 Vac or 200 to 254 Vac by changing the connections of the power transformer taps.

The voltage and current rating are indicated on the rear panel.

When changing voltages, change the connections of the power supply transformer, and the voltage and current designation plate on the rear panel. Order the plates from Anritsu Electric Co., Ltd. if necessary.

- (2) In this manual, supply voltage and current rating are represented by [**] Vac and [***] A.
- (3) The relationships between power supply voltage and current rating are listed below.

** Vac	*** A
100 to 127 V	1.0 A
200 to 254 V	0.5 A

TABLE OF CONTENTS

	Page
SECTION 1 GENERAL	1-1
SECTION 2 COMPOSITION AND SPECIFICATIONS	2-1
2.1 Composition	2-1
2.2 Specifications	2-1
2.3 Peripheral Devices and Accessories	2-5
2.3.1 MH680A Tracking Generator	2-5
2.3.2 MH648A Preamplifier	2-6
2.3.3 Antenna	2-7
2.3.4 Packet IIe Personal Technical Computer ..	2-7
2.3.5 Accessories	2-8
SECTION 3 PRINCIPLES OF OPERATION	3-1
3.1 Introduction	3-1
3.2 Frequency Conversion Circuit	3-1
3.3 IF Circuit	3-2
3.4 Detection and Video Circuits	3-3
3.5 Sawtooth Generator and Local Oscillator Control Circuit	3-3
3.6 Controller	3-4
SECTION 4 PREPARATIONS	4-1
4.1 Safety Measures	4-1
4.2 Power-ON	4-2

TABLE OF CONTENTS (Cont.)

	Page
4.3	Gain Calibration 4-3
4.4	Frequency Display ZERO Calibration 4-4
4.5	TRACE ROTATION and V. POSITION Adjustment .. 4-4
SECTION 5	OPERATION 5-1
5.1	Description of Front and Rear Panels 5-1
5.2	Description of Controls 5-5
5.2.1	FREQUENCY 5-5
	(1) COARSE - FINE dial 5-5
	(2) START FREQ and CENTER FREQ 5-6
	(3) FREQ ZERO ADJ 5-6
5.2.2	MODE 5-7
	(1) DATA 5-7
	(2) REFERENCE LEVEL 5-7
	(3) MARKER LEVEL 5-8
	(4) FREQ SPAN 5-9
	(5) INPUT ATTEN 5-9
	(6) RBW 5-10
	(7) SWEEP TIME 5-11
5.2.3	COUPLED TO SPAN 5-12
5.2.4	COUPLED TO REF 5-14
5.2.5	VIDEO FILTER 5-15
5.2.6	SCALE 5-16
5.2.7	TRIG 5-17

TABLE OF CONTENTS (Cont.)

		Page
5.2.8	DISPLAY UNCAL	5-18
5.2.9	GAIN ADJ	5-18
5.2.10	INTENSITY	5-19
5.2.11	GP-IB	5-19
5.2.12	REFERENCE LEVEL (rear panel)	5-20
SECTION 6	MEASUREMENT	6-1
6.1	Typical Measurement	6-1
	(1) General measurement method	6-1
	(2) Improvement of frequency measurement accuracy	6-2
6.2	Modulated Wave Measurement	6-2
	(1) Measurement Procedure	6-2
	(2) AM wave measurement	6-3
	(3) Measurement of AM wave when modulation frequency is low	6-4
	(4) FM wave measurement	6-5
	(5) PAM wave measurement	6-6
6.3	Spurious measurement	6-7
	(1) Harmonic distortion measurement	6-7
	(2) Inter modulation product measurement ..	6-9
	(3) Random spurious signal measurement	6-9
	(4) Spectrum purity measurement	6-9

TABLE OF CONTENTS (Cont.)

	Page
6.4 Field Strength Measurement	6-10
(1) Measurement in dB μ units	6-10
(2) Direct reading measurement of field strength using the specified antenna	6-10
(3) Antenna coefficient display	6-11
SECTION 7 DAILY MAINTENANCE AND STORAGE	7-1
7.1 Daily Maintenance	7-1
7.2 Storage	7-1
7.2.1 Storage Precautions	7-1
7.2.2 Recommended Storage Conditions	7-2
APPENDIX BLOCK DIAGRAM	A-1

SECTION 1

GENERAL

The MS610A Spectrum Analyzer has a wide frequency range of 10 kHz to 2 GHz, and covers a broad range from the video band to the UHF/VHF band.

It is used mainly for spurious response measurement of radio equipment, etc., assembly line adjustment, distortion measurement of various performance elements and circuits (for example, in amplifiers), and broadcast signal panoramic reception and EMI (Electro Magnetic Interference) measurements, etc.

The MS610A has multiple functions for these uses: a coupling function, measured level digital display function for efficient measurement, a GP-IB function, which allows simple automation of measurement, and an EMI measurement function with QP (Quasi Peak) detector. The last two are available as options.

A tracking generator (MH680A) is available as a peripheral device for transmission measurement.

SECTION 2
COMPOSITION AND SPECIFICATIONS

2.1 Composition

Table 2-1 Composition

Item	No.	Name	Q'ty
Instrument	1	MS610A Spectrum Analyzer	1
Accessories Supplied	2	Coaxial Cable S-5DWP•5D2W•S-5DWP 1 m	1
	3	Coaxial Cable BNC-P•RG-55/U•N-P 1 m	1
	4	Power Cord	1
	5	Fuse AC *** A	2
	6	Operation Manual	1

2.2 Specifications

Table 2-2 Specifications

Frequency	
Frequency Range	10kHz to 2GHz
Display and Accuracy	4-digit LED, resolution 1MHz, CENTER/START switchability, accuracy of ±10MHz
Frequency Span	Span *1 Zero and 0.1MHz to 1GHz, 1, 2, 5 sequence
	Full Span 0 to 2GHz (with marker)
	Accuracy ±5%

*1. Span width is shown on a ten-section scale on the screen.

Table 2-2 Specifications (Cont.)

Frequency (Cont.)			
Resolution	Resolution	1kHz to 1MHz (3dB) 1, 3 sequence	
	Bandwidth	(For option 02, 9kHz, 120kHz: 6dB bandwidth)	
	Selectivity	15:1 or less; 60dB/3dB Bandwidth Ratio (For 9kHz, 120kHz, 60dB/6dB bandwidth ratio)	
Stability	Stability	100kHz or less/5 minutes, one hour, after power-on, for fixed frequency settings	
	Residual FM	5kHzp-p or less; sweep time 0.1 second or less	
	Noise Sidebands	70dB or more Resolution Bandwidth: 1kHz Video Filter: 100Hz 30kHz away from signal	
Amplitude			
Measurement and CRT Display Range	LOG	10dB/div	-115 to +20dBm CRT Display Range 72dB
		2dB/div	-66 to +20dBm CRT Display Range 16dB
	LIN		-66 to +20dBm CRT Display Range 0 to 1
Log Scale Linearity		±1.5dB/72dB	±1dB/16dB
Frequency Response	±1.5dB (100kHz to 1.5GHz)	+2dB -3dB (1.5GHz to 2GHz)	When setting an input attenuator to 10dB or more.
Reference Level *2	10dB/div	-50dBm to +20 dBm in 1dB steps	
	2dB/div	-50dBm to +20dBm in 0.5dB steps	
	LIN	-60dBm to +20dBm in 0.5dB steps	
	Accuracy	±1.5dB or less	

*2. Reference level scale is the top line on the screen.

Table 2-2 Specifications (Cont.)

Amplitude (Cont.)		
Dynamic Range	Average Noise Level	-115dBm or less Resolution Bandwidth: 1kHz Video Filter: 100Hz Frequency: 1MHz or more
	Second and Third Harmonic Distortion Factors	70dB or less for -30dBm input level Input attenuator: 0dB Frequency: 100kHz or more
	Residual Spurious Response	-100dBm or less for 50Ω Input Termination Input attenuator: 0dB Frequency: 100kHz or more
Video Filter		100Hz, 10kHz, OFF
Resolution Bandwidth Gain Variation		±1dB
Marker Level	Display	4-digit LED. The Max. level in the brightened portion at the center of the screen is displayed.
	Resolution	0.1dB Scale: 10dB/DIV and 2dB/DIV
Level Unit Switching		dBm, dBμ, dBμ/m
Coupled Function	COUPLED TO SPAN Resolution bandwidth and sweep time are optimized and set automatically by ganging with the FREQ SPAN.	
	COUPLED TO REF Input Attenuator is optimized and set automatically by ganging with the REF LEVEL value. (Mixer level: -30dBm or less)	
Input	Terminal	50Ω, VSWR 1.5 or less, Type N-connector (when input attenuator is set to 10dB or more)
	Input Attenuator	0 to 50dB, in 10dB steps; 5 steps

Table 2-2 Specifications (Cont.)

Sweep	Time	10ms to 10s 1, 2, 5 sequence; 10 steps
	Trigger	FREE RUN, LINE, VIDEO, SINGLE
Calibrator Output	50MHz \pm 150kHz, -30dBm \pm 0.5dB, BNC Connector	
CRT	Graticule Division: 8 DIV x 10 DIV, 6-inch screen (diagonal measurement), P39 phosphor (medium persistence)	
External Control (for Option 01)	Compatible with IEEE STANDARD 488-1978, IEC625-1 Interface functions: SH1, AH1, T6, L4, SRO, RL1, PPO, PC1, DT0, CO. All functions except the power switch, CRT brightness, frequency adjustment, gain adjustment volume, and frequency setting dial, can be controlled.	
Detector-Time Constant (For Option 02)	Charge-time constant	1ms \pm 20%
	Discharge-time constant	160ms \pm 20% (for 9kHz resolution bandwidth) 550ms \pm 20% (for 120kHz resolution bandwidth)
Display Section Time Constant (For Option 02)	100ms \pm 30%	
Power	** Vac \pm 10%, 50/60Hz, 75VA	
Dimensions and Weight	177H, 284W, 351Dmm, 13.5kg	
Rated Operating Temperature Range	0 to 50°C	

Options 01: GP-IB
 02: QP (Quasi Peak) Detector

2.3 Peripheral Devices and Accessories

For using the MS610A more effectively, peripheral devices, application parts, and accessories are available. These are all sold separately.

2.3.1 MH680A Tracking Generator (100 kHz to 2 GHz)

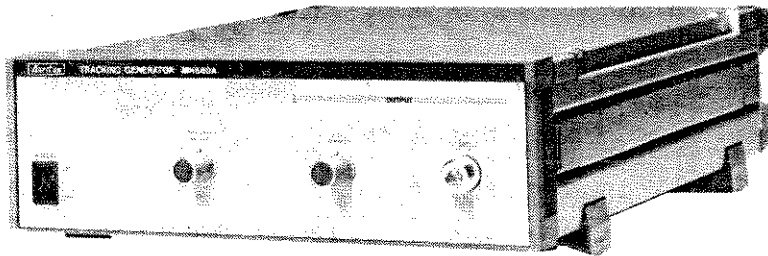

The MH680A Tracking Generator is a wideband sweep signal source for use with the MS610A Spectrum Analyzer. It allows direct reading measurement of the transmission characteristics of wideband amplifiers, filters, and circuit networks.

Frequency Range	100 kHz to 2 GHz
Output Level Range	-10 dBm to 0 dBm (Continuously variable)
Output Frequency Response	± 0.5 dB (at 0 dBm point)
Output Terminal	50 Ω , Type N connector

The above specifications are tentative.

2.3.2 MH648A Preamplifier

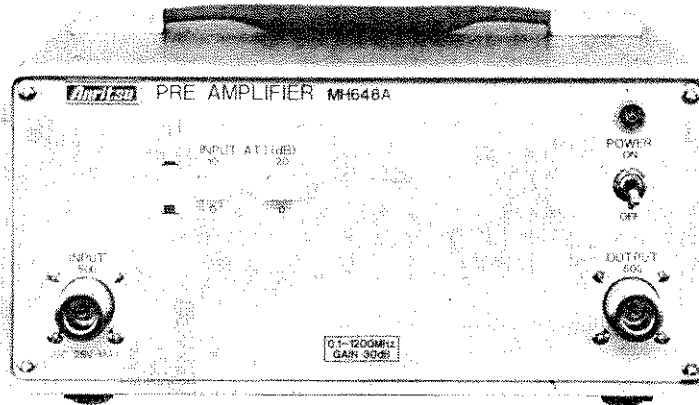

The MS648A improves the sensitivity of the MS610A Spectrum Analyzer by a maximum of 24 dB.

Frequency Range	0.1 to 1200 MHz
Gain	30 \pm 1 dB (0.5 to 800 MHz) 30 +1.5/-6 dB (0.1 to 1200 MHz)
Noise Figure	6 dB or less (0.5 to 800 MHz) 8 dB or less (0.1 to 1200 MHz)
Input Attenuator	0, 10, 20, 30 dB
Power	AC ** V \pm 10%, 50/60 Hz, 10 VA or less, or, +21 to +30 Vdc, 120 mA or less

2.3.3 Antenna

When the following antennas are used, the measured field strength can be read directly on the digital display.

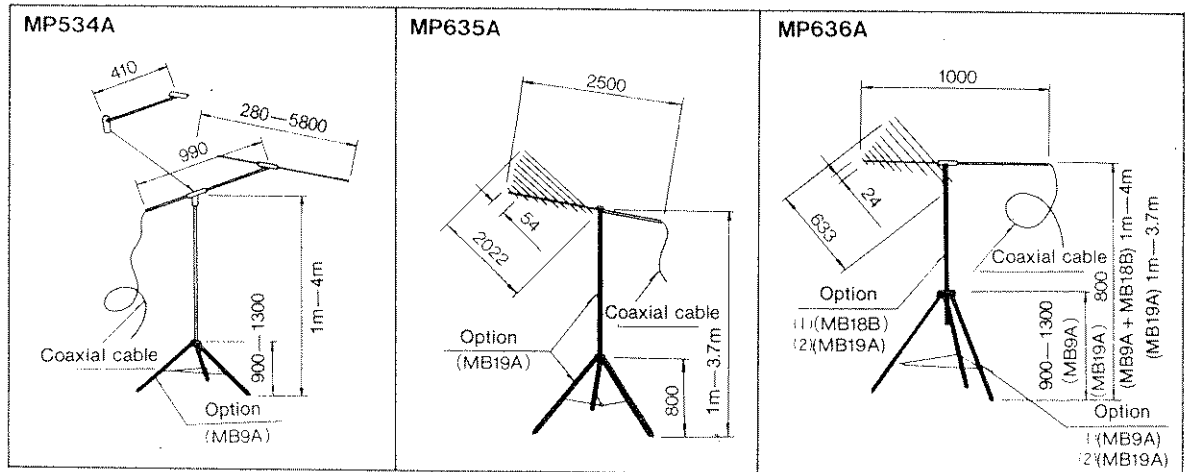

(Dimensions are in millimeters unless otherwise indicated.)

2.3.4 Packet IIe Personal Technical Computer

The Packet IIe is a personal computer for high speed control and scientific applications. With an MC68000 high-performance 16-bit microprocessor, it uses ANSI extended BASIC-based FDOS. Since commands which facilitate measurement and control by using a GP-IB are provided, the MS610A can be easily automated and remotely controlled by installing the GP-IB option; perfect for adjustment and inspection labor-saving.

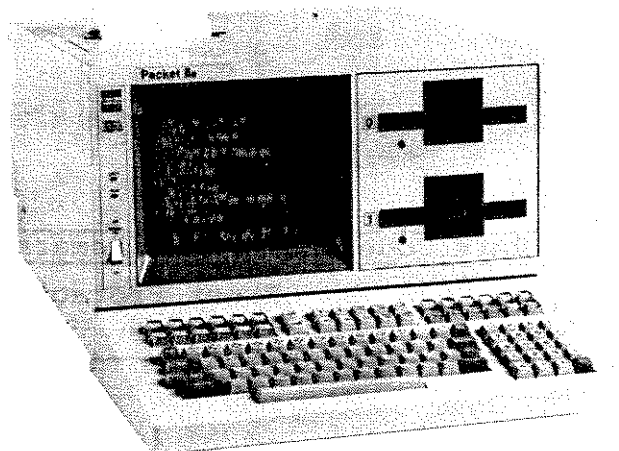

2.3.5 Accessories

(1) CRT filter

This filter can be easily attached and detached. If specific lines are drawn directly on the filter, quality judgement, etc. is easy.

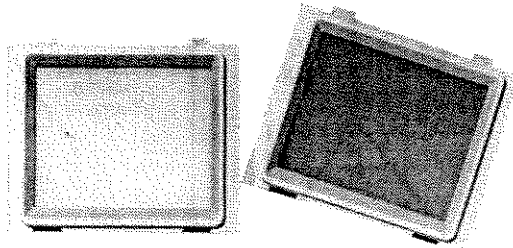

Name	Part Code	Remarks
CRT filter (Smoked)	B 0075	Color (Smoked)

(2) Carrying bag

A carrying bag, which is convenient in field and other outdoor measurements, and in maintenance service, etc., at the site, is available.

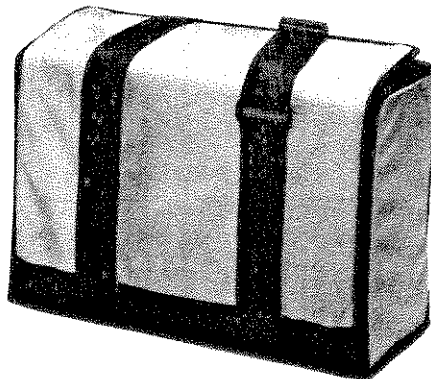

Name	Part Code	Remarks
Carrying bag	B 0076	Front Protection Cover Included

(3) Carrying case

These carrying cases are convenient when transporting the instrument by car, airplane, etc.

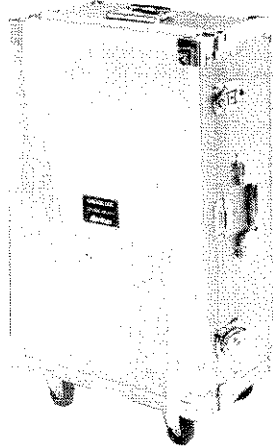

With Casters

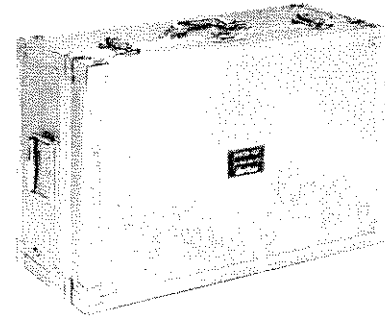

Without Casters

Name	Part Code	Remarks
Carrying case with casters	B 0077	Front and rear protection covers included
Carrying case without casters	B 0078	Front and rear protection covers included

Dimensions: 290H, 650W, 410D mm
(Excluding casters, handle, etc.)

SECTION 3

PRINCIPLES OF OPERATION

3.1 Introduction

The MS610A is a superheterodyne type scanning spectrum analyzer. The block diagram is shown in Fig. 3-1.

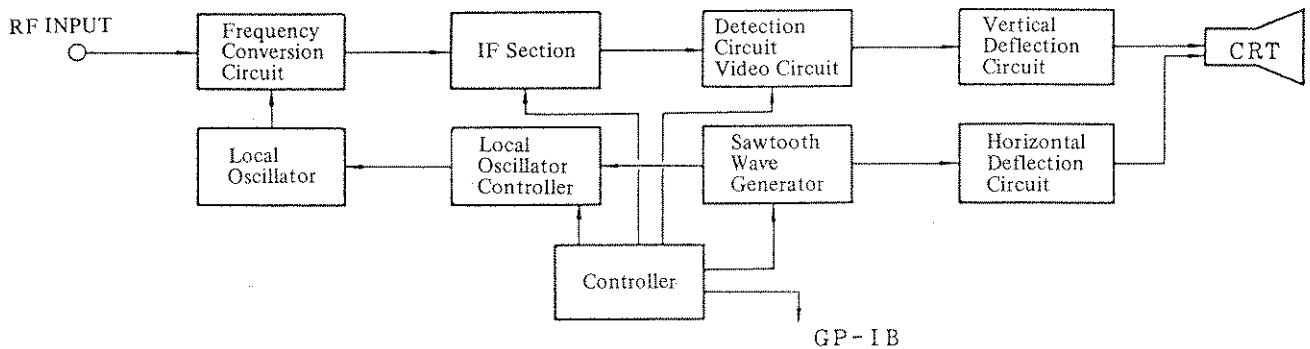

Fig. 3-1 MS610A Block Diagram

The input signal is converted to an IF signal by the frequency conversion circuit mixer. This IF signal is detected and is applied to the vertical deflection plate of the CRT. The sweep signal is generated by a sawtooth wave generator and is applied to the horizontal deflection plate of the CRT. This sweep signal simultaneously sweeps the local oscillator, and frequency sweep corresponding to the horizontal axis of the CRT is performed. Each section is controlled by a controller using a microcomputer.

3.2 Frequency Conversion Circuit

The MS610A is a triple superheterodyne system. The input signal is converted to a 3.5 MHz IF signal after triple frequency conversion as shown in Fig. 3-2. That is, after the input signal is beat-up to 2.5214 GHz to prevent image response, it is converted to 21.4 MHz, then converted to 3.5 MHz.

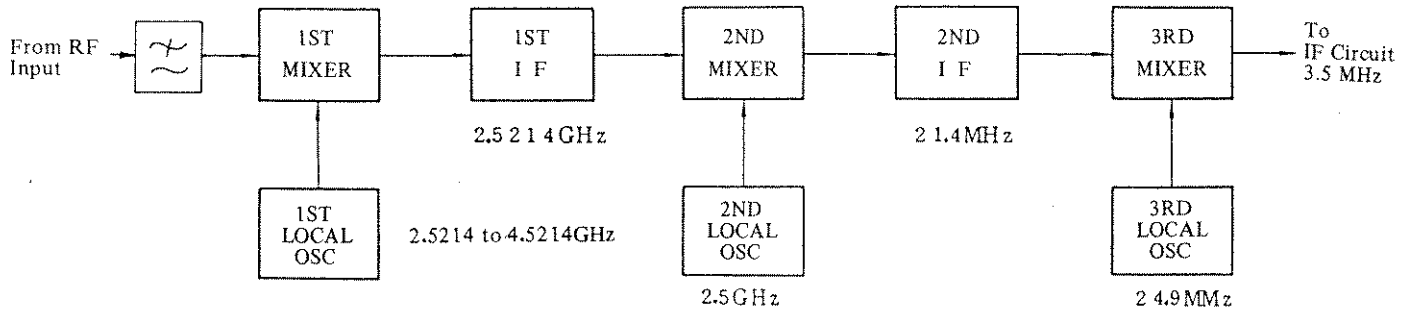

Fig. 3-2 MS610A Frequency Conversion Circuit

3.3 IF Circuit

The composition of the IF circuit is shown in Fig. 3-3.

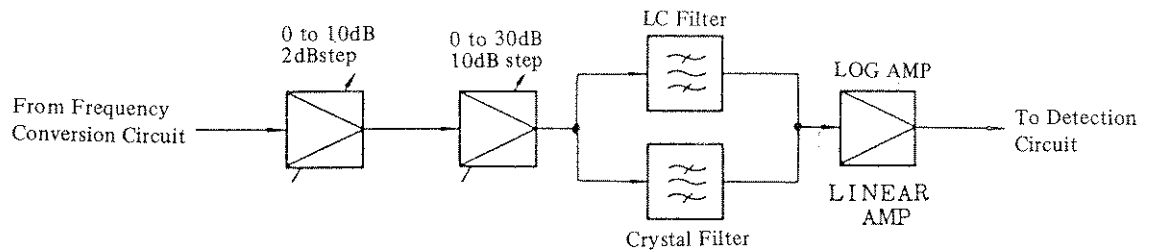

Fig. 3-3 MS610A IF Circuit

After the 3.5 MHz IF signal is passed through a 2 dB step 0 to 10 dB variable gain amplifier, and a 10 dB step 0 to 30 dB variable gain amplifier, it is sent through the LC filter and crystal filter.

The crystal filter determines the 1 kHz to 3 kHz bandwidth and the LC filter determines the 10 kHz to 1 MHz bandwidth. The signals from these filters are amplified by the LOG and LINEAR amplifiers which determine the vertical axis scale.

3.4 Detection and Video Circuits

The 3.5 MHz signal from the IF circuit is detected by the detection circuit and amplified to 0 to 4 V by the video circuit.

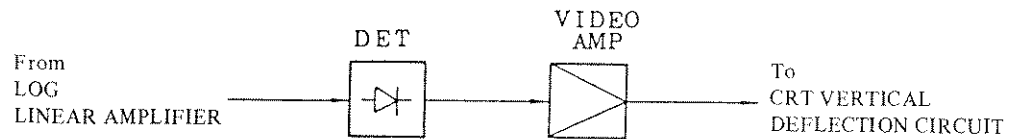

Fig. 3-4 MS610A Detection and Video Circuits

3.5 Sawtooth Generator and Local Oscillator Control Circuit

The sweep time is determined by the SWEEP TIME switch; the sawtooth wave signal sweeps the 1st local oscillator through the FREQ SPAN switch, which controls the FREQ SPAN. The SWEEP TIME switch and FREQ SPAN switch are controlled by the controller. The sawtooth wave signal also sweeps the CRT horizontal axis.

A YTO tuned coil is used in the 5 MHz to 2 GHz wide band sweep and a YTO FM coil is used in the 100 kHz to 2 MHz narrow band sweep.

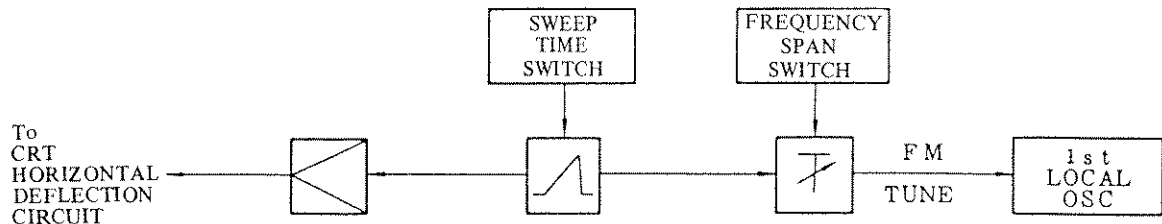

Fig. 3-5 MS610A Sawtooth Generator and Local Oscillator Control Circuit

3.6 Controller

The MS610A uses a CPU controller. Each circuit is controlled via an interface circuit for panel key inputs. GP-IB control is also performed.

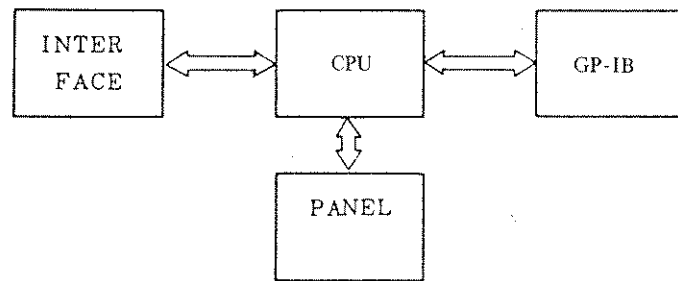

Fig. 3-6 MS610A Controller

SECTION 4

PREPARATIONS

4.1 Safety Measures

(1) Power supply

The MS610A operates on 50 Hz/60 Hz AC voltage of $\pm 10\%$ of the value shown on the rear panel.

WARNING

To avoid electric shock, when using a 2-pin power outlet, always ground the rear panel \perp terminal or the power cord ground terminal.

(2) Installation site environment conditions

The MS610A normally operates at an ambient temperature of 0 to 50°C. However, do not use it in locations where:

- a. vibrations are severe.
- b. it is humid and dusty.
- c. there is exposure to direct sunlight.
- d. there is exposure to active gases.

CAUTION

When the MS610A is used at room temperature after being used for long periods at a low temperature, (such as 0°C), it may be shorted by water droplets due to condensation. When water droplets are suspected of having collected, dry the instrument thoroughly before turning on the power switch.

(3) Maximum input level

[+20 dBm]: Do not input a level higher than this since it will damage the internal circuits.

4.2 Power-ON

After checking that the AC voltage of the power supply used is within the specified value, insert the rear panel power cord into the power plug. When the power switch is set to ON, the LED on the display lights.

Display and setting are shown below.

Frequency Display	Frequency Dial Setting
START FREQ	OFF
CENTER FREQ	OFF
REFERENCE LEVEL display	0 dBm
FREQ SPAN	F (FULL)
INPUT ATTEN	30 dB
RBW	0.3 MHz
SWEEP T	0.1 S
COUPLED TO REF	ON
COUPLED TO SPAN	ON
VIDEO FILTER	OFF
SCALE	10 dB/DIV
TRIG	FREE RUN
GP-IB	OFF

Check these settings.

After a while, slowly turn the INTENSITY knob clockwise and adjust the brightness at which the screen marker point display and measured waveform display are easy to see.

4.3 Gain Calibration

To measure absolute level, calibrate the gain before making any measurements.

(1) Settings

CENTER FREQ	ON
COUPLED TO REF	ON
COUPLED TO SPAN	ON
REFERENCE LEVEL	-30 dBm
FREQ SPAN	5 MHz
VIDEO FILTER	OFF
SCALE	2 dB/DIV
TRIG	FREE RUN

- (2) Connect the rear panel [CAL OUTPUT] connector to the front panel [RF INPUT] connector with the cable supplied. Set the CENTER FREQUENCY to 50 MHz with the frequency setting COARSE dial and adjust with the frequency setting FINE dial to get a fundamental calibration signal wave at the center of the screen.

Next, turn the GAIN ADJ knob and set the top of the 50 MHz spectrum to the LOG reference line (the top scale line of the screen). This completes gain calibration.

4.4 Frequency Display ZERO Calibration

Set the measurement parameters as follows:

(1) Setting

CENTER FREQ	ON
COUPLED TO REF	ON
COUPLED TO SPAN	ON
REFERENCE LEVEL	+10 dBm
FREQ SPAN	5 MHz
VIDEO FILTER	OFF
SCALE	10 dB/DIV
TRIG	FREE RUN

(2) Frequency Display Zero Calibration

Set the frequency setting FINE dial to five turns from the beginning. Then, turn the frequency setting COARSE dial and display the zero frequency spectrum at the center of the screen.

While in this state, turn the FREQ ZERO ADJ semifixed variable resistor with a screwdriver and set it so that the frequency display changes from 1 to 0. This completes frequency display zero calibration.

4.5 TRACE ROTATION and V. POSITION Adjustment

(1) Setting

REFERENCE LEVEL	0 dBm
INPUT ATTEN	20 dB
FREQ SPAN	0 MHz
SCALE	LINEAR

(2) Adjustment

Adjust the TRACE ROTATION using a screwdriver to set the display line horizontally, then adjust V. POSITION to set it on the bottom horizontal scale line of the screen.

SECTION 5

OPERATION

5.1 Description of Front and Rear Panels

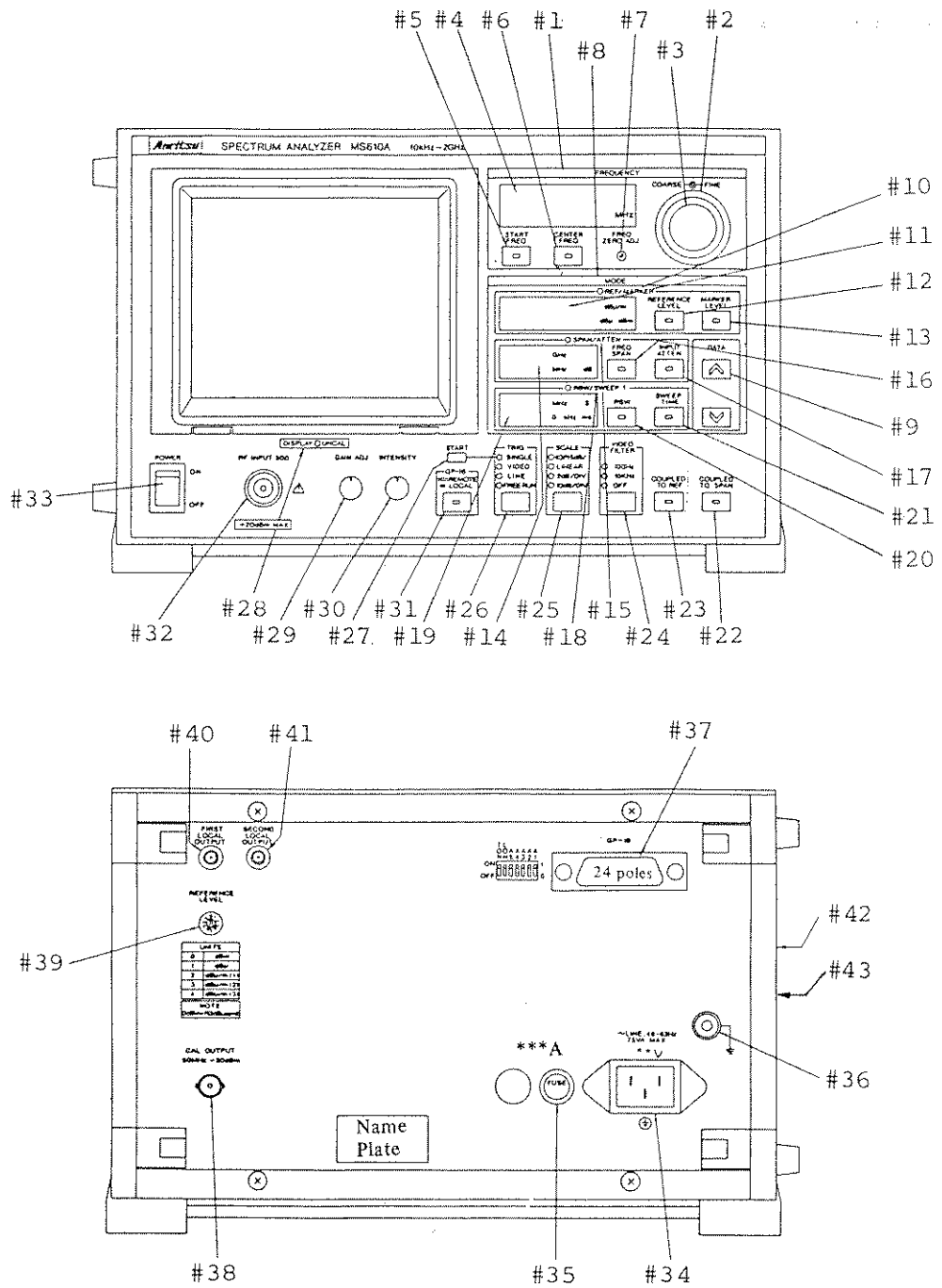

Fig. 5-1 Front and Rear Panel Layout

Table 5-1 Front and Rear Panel

Block Name	Operating Point	Description
FREQUENCY #1		This block contains the frequency related functions.
	COARSE dial #2	0 to 2 GHz coarse setting dial. 10 turns. Sets all frequencies.
	FINE dial #3	Fine setting dial. 10 turns. Sets 2 MHz.
	#4	Displays the frequency according to the COARSE dial.
	START FREQ #5	The displayed frequency becomes the screen START position.
	CENTER FREQ #6	The displayed frequency becomes the screen CENTER position.
	FREQ ZERO ADJ #7	Calibrates the displayed frequency.
MODE #8		This block contains the screen setting functions.
	DATA #9	Sets the measurement condition of the selected key in MODE.
	 #10	LED which lights when the REFERENCE LEVEL is pressed.
	REF/MARKER #11	Displays the REFERENCE LEVEL or MARKER LEVEL.
	REFERENCE LEVEL #12	The REFERENCE LEVEL can be displayed and set.
	MARKER LEVEL #13	Outputs a brightened marker at the center of the screen. The peak level is displayed.
	SPAN/ATTEN #14	LED which lights when the FREQ SPAN or INPUT ATTEN key is pressed.
	#15	Displays the FREQ SPAN or INPUT ATTEN setting.

Table 5-1 Front and Rear Panel (Cont.)

Block Name	Operating Point	Description
MODE #8 (cont.)	FREQ SPAN #16	This FREQ SPAN can be displayed and set.
	INPUT ATTEN #17	Input attenuator set value can be displayed and set.
	RBW/SWEEP T #18	LED which lights when the RBW or SWEEP TIME key is pressed.
	#19	Displays RBW or SWEEP TIME.
	RBW #20	RBW 3 dB bandwidth of IF can be displayed and set.
	SWEEP TIME #21	Sweep time can be displayed and set.
	COUPLED TO SPAN #22	RBW and SWEEP T. are automatically set to the optimum value corresponding to FREQ SPAN setting. The LED lights while this function is available.
	COUPLED TO REF #23	INPUT ATTEN is automatically set to the optimum value corresponding to REF level setting. The LED lights while this function is available.
	VIDEO FILTER #24	Selects the VIDEO FILTER. The selected value is indicated by an LED.
	SCALE #25	Sets the screen vertical scale. The set value is indicated by an LED. (5 dB can be set only when the QP [Quasi Peak] option is installed.)
	TRIG #26	Selects the trigger mode. The selected mode is indicated by an LED.
	START #27	Starts sweep when SINGLE is selected at TRIG mode.
	DISPLAY UNCAL #28	Lights when the measured value (screen display) does not satisfy the measurement specifications.
	GAIN ADJ #29	Finely adjusts the vertical gain. (Used at level calibration.)

Table 5-1 Front and Rear Panel (Cont.)

Block Name	Operating Point	Description
MODE #8	INTENSITY #30	Adjusts the brightness of the screen. (The brightness of the marker does not change.)
	GP-IB #31	Changes the MS610A from the remote state (being controlled via the GP-IB) to the local state. The LED lights in the remote state. (Only when GP-IB option is installed.)
	RF INPUT #32	Input terminal for signal to be measured.
	POWER #33	Power switch.
	#34	AC input. Connects to the power cord.
	#35	Contains the power fuse.
	#36	Ground terminal.
	GP-IB #37	Connector and address switch which are provided when the GP-IB option is installed.
	CAL OUTPUT #38	Calibration signal output (50 MHz -30 dBm).
	REFERENCE LEVEL #39	Switch which changes the REFERENCE LEVEL display units.
	FIRST LOCAL OUTPUT #40	First local output terminal for the optional MH680A Tracking Generator.
	SECOND LOCAL OUTPUT #41	SECOND LOCAL output terminal for the optional MH680A Tracking Generator. (The connectors #40 and #41 are provided with the MH680A.)
	TRACE ROTATION #42	Adjusts the tilt of the waveform on the screen.
	V. POSITION #43	Adjusts the VERTICAL POSITION of the waveform on the screen.

5.2 Description of Controls

5.2.1 FREQUENCY

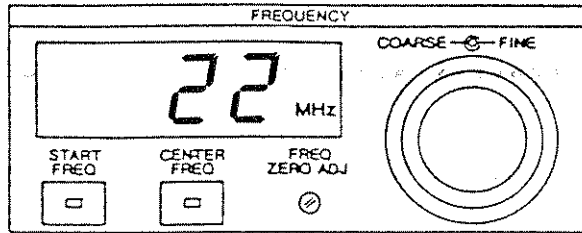

Fig. 5-2 COARSE - FINE Dial

(1) COARSE - FINE dial

<Function>

Sets the frequency.

<Setting range>

COARSE dial 0 to 2 GHz (all frequencies)
coarse adjustment dial.

All the frequencies are set with 10 turns of the dial. The frequency is displayed on the frequency display with a 1 MHz resolution.

FINE dial Fine adjustment dial.

About 2 MHz is set with 10 turns of the dial.

(2) START FREQ and CENTER FREQ

<Function>

Determines the display frequency position on the screen.

START FREQ The displayed frequency becomes the screen START position.

CENTER FREQ The displayed frequency becomes the screen CENTER position.

However, at FULL SCAN, both START FREQ and CENTER FREQ do not operate.

(3) FREQ ZERO ADJ

<FUNCTION>

Used for the calibration of the display frequency.

<Adjustment method>

In the CENTER FREQ mode, the zero beat is set to the center of the screen and this control is adjusted to the point at which the indicated frequency changes from 1 MHz to 0 MHz.

5.2.2 MODE

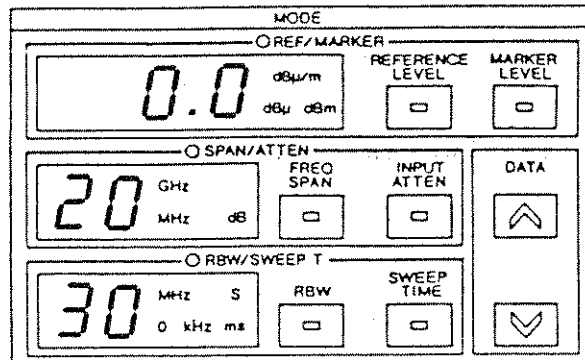

Fig. 5-3 MODE Keys

<Function>

The display is divided into three areas designated REF/MARKER, SPAN/ATTEN, and RBW/SWEEP.T. Each area has two setting items. When the key of one of these two items is pressed, one of the area lamps lights, along with the lamp of the key pressed. Then, the mode to which the DATA key is set is known and the display indicates the value at that time.

(1) DATA

<Function>

Sets the item of the pressed MODE key.
(Unrelated to MARKER LEVEL selection.)

(2) REFERENCE LEVEL

<Function>

Displays the REFERENCE LEVEL and the value can be changed by DATA keys sequentially. (When the DATA key is pressed continuously, the set value changes continuously.)

<Setting range>

When SCALE 10 dB/DIV set -50.0 to +20.0 dBm, 63
to 133 dB μ , variable in
1 dB steps

When SCALE 2 dB/DIV set -50.0 to +20.0 dBm, 63
to 133 dB μ , variable in
0.5 dB steps

When LINEAR set -60.0 to +20.0 dBm, 53
to 133 dB μ , variable in
0.5 dB steps

(dBm and dB μ units can be exchanged for other by
switching the rear panel REFERENCE LEVEL switch.)

(3) MARKER LEVEL

<Function>

Outputs a brightened marker at the center of the
screen and displays the maximum level in the
brightened portion.

<Setting range>

Marker (brightened portion) should be set in the range
below +1.9 dB of REF LEVEL on the CRT when SCALE
10 dB/DIV and in the range from -19.9 to +0.3 dB of
REF LEVEL when SCALE 2 dB/DIV. When this range is
exceeded, the unit display flashes to indicate that
the level display is unsuitable.

<Notes>

- . Not operative in the LINEAR SCALE, FULL SPAN
setting, when the REF/MARKER lamp is not lit.
- . Differs from FULL SPAN MARKER function.
- . MARKER brightness is fixed. If INTENSITY is too
high, the marker cannot be seen.

<Other functions> Field strength measurement

When the rear panel rotary switch is set to dB μ /m (1), (2), (3), the measurement result for the field strength, which is the Max. level on the brightest marker portion, is directly displayed in dB μ /m unit. Corresponding to each antenna coefficient, when the \wedge key is pressed while the MARKER LEVEL key is pressed, only the antenna coefficient of the display frequency is displayed. When the \vee key is pressed, the display returns to the dB μ /m measurement display.

(4) FREQ SPAN

<Function>

The FREQ SPAN width is displayed and can be sequentially set with the DATA keys.

<Setting range>

F (FULL SPAN 2 GHz), 1 GHz, 0.5 GHz, 0.2 GHz, 0.1 GHz
50 MHz, 20 MHz, 10 MHz, 0.5 MHz, 0.2 MHz, 0.1 MHz,
0 MHz

<FULL SPAN MARKER>

When set to F (FULL SPAN), a bright marker appears on the screen. This marker indicates the frequency (display frequency) set with the COARSE dial. When the center of the marker is set to the spectrum to be analyzed and SPAN is made narrower, that spectrum can be easily set at the center of the screen.

(5) INPUT ATTEN

<Function>

The input attenuator set value is displayed and can be set with the DATA keys incrementally or decrementally.

(7) SWEEP TIME

<Function>

SWEEP TIME is displayed and can be sequentially set with the DATA keys.

<Setting_range>

10 s (seconds), 5 s, 2 s, 1 s, 0.5 s, 0.2 s, 0.1 s, 50 ms, 20 ms, 10 ms

When the QP (Quasi Peak) option is included, 99 s, 70 s, 60 s, 50 s, 40 s, 30 s, and 20 s can also be set.

5.2.3 COUPLED TO SPAN



Fig. 5-5 COUPLED TO SPAN Key

<Function>

The RBW and SWEEP TIME are automatically set to the optimum state corresponding to the FREQ SPAN setting. The SWEEP TIME is also set to the optimum state when the VIDEO FILTER is set.

<Setting>

When the key is pressed and the key lamp is lit, setting is obtained.

At this time, even if the RBW or SWEEP TIME DATA keys are set, pressing this key sets them to the FREQ SPAN setting. RBW and SWEEP TIME are automatically changed corresponding to FREQ SPAN by the DATA keys; then, the SPAN/ATTEN area lamp lights. This function is reset and the lamp is turned off by pressing the set key again or by pressing the RBW or SWEEP TIME key.

Table 5-2 FREQ SPAN, RBW, and SWEEP TIME Relationships

FREQ SPAN (Hz)	R.B.W (Hz)	SWEEP TIME		
		V.F = OFF	V.F = 10 kHz	V.F = 100 Hz
F (2 G)	0.3 M	0.1 S	2 S	10 S (UNCAL)
1 G	0.1 M	0.2 S	2 S	10 S (UNCAL)
0.5 G	0.1 M	0.1 S	1 S	10 S (UNCAL)
0.2 G	0.1 M	0.1 S	0.5 S	10 S (UNCAL)
0.1 G	30 K	0.2 S	1 S	10 S (UNCAL)
50 M	30 K	0.1 S	0.5 S	10 S (UNCAL)
20 M	30 K	0.1 S	0.2 S	10 S
10 M	10 K	0.2 S	0.2 S	10 S (UNCAL)
5 M	10 K	0.1 S	0.1 S	10 S
2 M	10 K	0.1 S	0.1 S	5 S
1 M	3 K	0.2 S	0.2 S	5 S
0.5 M	3 K	0.1 S	0.1 S	2 S
0.2 M	3 K	0.1 S	0.1 S	1 S
0.1 M	1 K	0.2 S	0.2 S	2 S
0 M	30 K	0.1 S	0.1 S	2 S

5.2.4 COUPLED TO REF



Fig. 5-6 COUPLED TO REF Key

<Function>

INPUT ATTEN is automatically set to the optimum corresponding to REF LEVEL setting.

<Setting>

When the key is pressed and the lamp is lit, setting is obtained.

At this time, even if the INPUT ATTEN DATA key is set, pressing this key causes REF LEVEL setting and INPUT ATTEN is automatically changed corresponding to REF LEVEL by the DATA keys; the REF/MARKER area lamp lights.

This function is reset and the key lamp is turned off by pressing the set key again or by pressing the INPUT ATTEN key.

Table 5-3 Relationship between REF LEVEL and INPUT ATTEN

REF LEVEL (dBm)	INPUT ATTEN (dB)	
	LOG SCALE	LINEAR SCALE
12 to 20	50	50
2 to 11.5	40	40
-8 to 1.5	30	30
-18 to -8.5	20	20
-28 to -18.5	10	10
-50 to -28.5	0	
-60 to -28.5		0

0 dBm is 113 dB μ .

5.2.5 VIDEO FILTER



Fig. 5-7 VIDEO FILTER Key

<Function>

Smoothing of noise and improvement in quality of waveform visibility.

<Setting>

The video filter is set in OFF → 10 kHz → 100 Hz → OFF order and the set value is indicated by the lamp when the keys are pressed.

OFF	Video filter not used.
10 kHz	10 kHz video filter used.
100 Hz	100 Hz video filter used.

5.2.6 SCALE

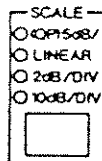

Fig. 5-8 SCALE Key

<Function>

Sets the screen vertical axis scale.

<Setting>

The scale is set in 10 dB/DIV → 2 dB/DIV → LINEAR → 10 dB/DIV order and the set value is indicated by the lamp when the keys are pressed.

10 dB/DIV Screen full scale of 80 dB in the
10 dB/DIV scale

Top line is the reference level.
Screen display range of 0 to -72 dB is
calibrated. (0 dB is top line of
screen display.)

2 dB/DIV Screen full scale of 16 dB in the
2 dB/DIV scale

LINEAR 1 to 0 display

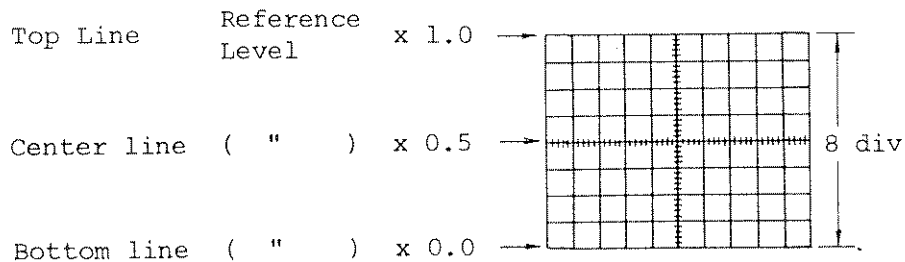

(QP) 5 dB/ Can be used in the EMI measurement (QP
detector) option.
Screen full scale of 40 dB in 5 dB/DIV
scale.

5.2.7 TRIG

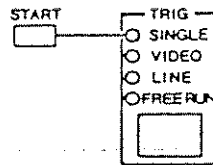

Fig. 5-9 TRIG Keys

<Function>

Selects the sweep trigger mode.

The mode is set in FREE RUN → LINE → VIDEO → SINGLE → FREE RUN order and the mode set is indicated by the lamp when the key is pressed.

When the single mode is selected, sweep is performed by pressing the START key.

<Setting>

FREE RUN	Sweep is repeated by the timing set internally.
LINE	Sweep is synchronized to the frequency of the AC line (power supply).
VIDEO	Sweep is synchronized to the video signal.
SINGLE	One sweep is performed by pressing the START key.

5.2.8 DISPLAY UNCAL

DISPLAY UNCAL

Fig. 5-10 DISPLAY UNCAL Lamp

<Function>

When sweep is performed at a time shorter than the optimum SWEEP TIME determined by the FREQ SPAN, RBW, and VIDEO FILTER, the lamp lights to indicate that there is an error in the measured display value.

5.2.9 GAIN ADJ

GAIN ADJ



Fig. 5-11 GAIN ADJ Knob

<Function>

Knob for adjusting the gain. This is used to calibrate the absolute gain value.

And also used when setting the displayed signal level to the scale on the screen, etc.

5.2.10 INTENSITY

INTENSITY



Fig. 5-12 INTENSITY Knob

<Function>

Adjusts the brightness of the image on the screen.
The brightness of the marker does not change.

5.2.11 GP-IB

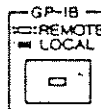

Fig. 5-13 GP-IB Key

<Function>

Sets the remote state to the local state when the GP-IB option is installed and the GP-IB is used. In the remote state, the key lamp lights to indicate that GP-IB is being used. When set to the local state by pressing the key, the lamp goes out and the instrument can be used by manual key operation.

5.2.12 REFERENCE LEVEL (rear panel)

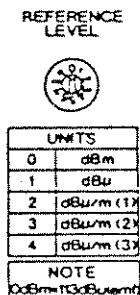

Fig. 5-14 REFERENCE LEVEL Switch

<Function>

Changes the REFERENCE LEVEL display units.

<Setting>

dBm	Displayed in dBm units.
dBμ	Displayed in dBμ units.
dBμ/m(1), (2), (3)	When the MARKER LEVEL is set to ON, the max. level of the marker portion at the center of the screen is directly displayed in dBμ/m. After compensation corresponding to each STANDARD ANTENNA's coefficient, the REFERENCE LEVEL is displayed in dBμ units.

SECTION 6
MEASUREMENT

6.1 Typical Measurement

(1) General measurement method

The device under test ("X") and the spectrum analyzer input connector are connected with a cable as shown in Fig. 6-1.

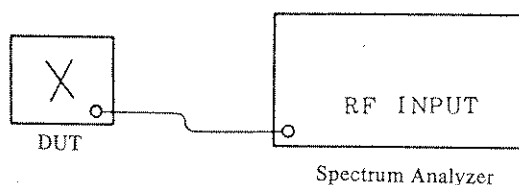

Fig. 6-1 Connection to ("X") Device Under Test

Initially, the unknown signal is received and measured over a wide band by FULL SPAN.

Reception of the signal is confirmed by looking at the screen. When only the FULL SPAN MARKER appears on the screen, the brightness is adjusted with the INTENSITY knob so that the entire screen brightens. When the spectrum does not appear, lower the reference level with the REFERENCE LEVEL key.

After the spectrum appears on the screen, the FULL SPAN MARKER is set with the spectrum to be measured at the center. Then, FREQ SPAN is narrowed, the dials are turned, the displayed spectrum is set to the center (for CENTER FREQ) of the screen, and the frequency display value is read.

When the MARKER LEVEL key is pressed, the level appears on the display.

(2) Improvement of frequency measurement accuracy

The specified center frequency accuracy of the MS610A is ± 10 MHz. However, more accurate frequency measurement can be performed by using the CAL OUT signal.

The CAL OUT signal is connected to RF INPUT by cable.

The n th harmonic spectrum of 50 MHz appears on the screen. When frequency deviation between the harmonic and the unknown signal is Δf , the frequency of the unknown signal is calculated to $50 n \pm \Delta f$.

The frequency accuracy of the harmonics of the CAL signal is $(n \times \pm 150 \text{ kHz})$ for the n th harmonic; FREQ SPAN accuracy is $\pm 5\%$.

6.2 Modulated Wave Measurement

Since the sideband spectrum of AM, PAM (Pulse amplitude modulation), FM, and other modulated waves is distributed above and below the carrier, the spectrum is measured by expanding the display on the screen with almost the same procedure.

(1) Measurement procedure

- (a) First, the instrument is set to the FULL SPAN mode, and the unknown signal is received.
- (b) The FULL SPAN MARKER is set to the spectrum to be measured with the COARSE dial.
- (c) COUPLED TO SPAN is set. The FREQ SPAN is narrowed and the spectrum is expanded while setting the center of the spectrum to the center of the screen with the COARSE and FINE dials.

(d) REF LEVEL is adjusted so that the amplitude of the spectrum is on the screen.

(2) AM wave measurement

When an AM wave is displayed, as shown in Fig. 6-2, by the measurement procedure described in (1), the carrier frequency f_c , modulation frequency f_m , and their levels P_c , P_1 , and P_2 (dBm or dB μ) can be measured.

The 2nd harmonic distortion of the modulation wave is given as $(P_1 - P_2)$.

The modulation factor is calculated by using the equation,

$$20 \log m/2 = P_c - P_1$$

This relationship is shown in Fig. 6-3. When SCALE 10 dB/DIV is used, since the highest 70 dB level difference is read directly from the screen, a low modulation percentage (as low as 0.06%) can be measured.

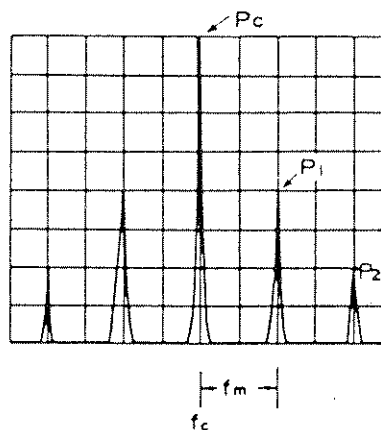

Fig. 6-2 AM Wave Spectrum Display

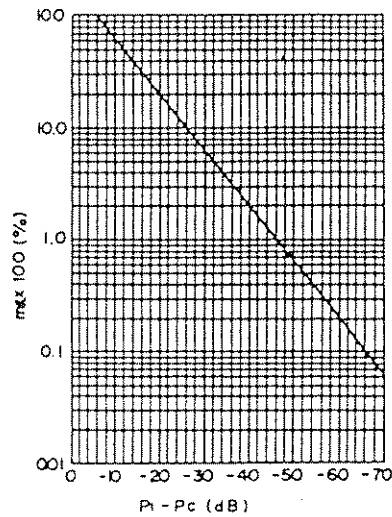

Fig. 6-3 AM Wave Modulation Factor and Sideband dB Display Level

- (3) Measurement of AM wave when modulation frequency is low

When the modulation frequency is low and analysis is impossible for the AM wave measurement of item (2), the FREQ SPAN setting is set to ZERO SPAN and the spectrum analyzer is operated as a fixed frequency receiver.

The following settings are made in addition to those of item (1):

SCALE	LIN
SPAN	0 (COUPLED TO SPAN)

When REF LEVEL is set to a suitable value and tuning is performed with the FINE dial, a waveform of the modulation signal appears on the screen. When the TRIG key is then set to VIDEO, the instrument is synchronized to the received signal and a static waveform appears on the screen as shown in Fig. 6-4.

In this case, since the horizontal axis is determined by SWEEP TIME, the display becomes a time domain display from which the period T (seconds) of the received signal can be directly read.

The modulation frequency f_m is given by $f_m = (1/T)$ (Hz). The modulation factor m is obtained from E_{max} , E_{min} , and E_c of Fig. 6-4 as follows:

$$m = (E_{max} - E_c) / E_c = (E_c - E_{min}) / E_c$$

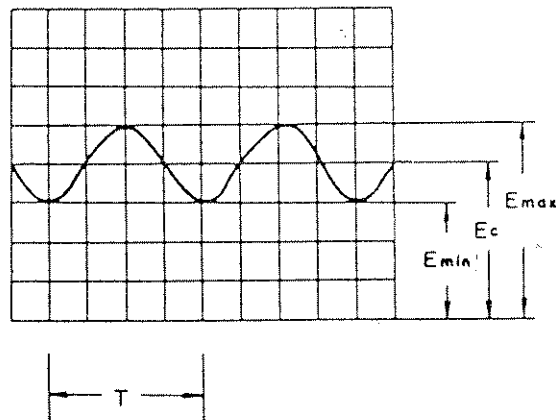

Fig. 6-4 AM Wave Time Domain Display Example

(4) FM wave measurement

When displayed as shown in Fig. 6-5 by the display expansion measurement procedure of item (1), the carrier frequency f_c , modulation frequency f_m , and the level of each sideband spectrum can be measured.

Moreover, since FM wave zero carrier amplitude can be checked from the spectrum displayed on the screen, the FM wave modulation index can be calibrated.

The modulation index at which the carrier amplitude becomes zero is shown in Table 6-1.

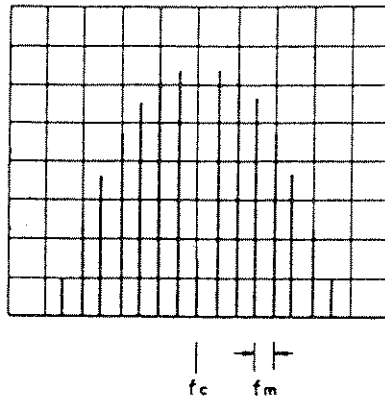

Fig. 6-5 FM Wave Spectrum Display Example

Table 6-1 Modulation Index When Carrier Amplitude Becomes Zero

Carrier Zero Order	Modulation Index
1	2.40
2	5.52
3	8.65
4	11.79
5	14.93
6	18.07
$n (n > 6)$	$18.07 + \pi (n - 6)$

(5) PAM wave measurement

The spectrum display of a PAM wave like that shown in Fig. 6-6 is obtained by the measurement display expansion procedure of item (1). The pulse width τ of the modulation pulse is obtained from the difference frequency f_r between the discontinuous points of the main lobe and side lobe of the pulse spectrum shown in Fig. 6-6(A) ($\tau = 1/f_r$).

Furthermore, when each sideband spectrum is analyzed by expanding the spectrum, the spectrum display shown in Fig. 6-6(B) is obtained and the carrier frequency f_c and pulse repetition frequency f_m are measured.

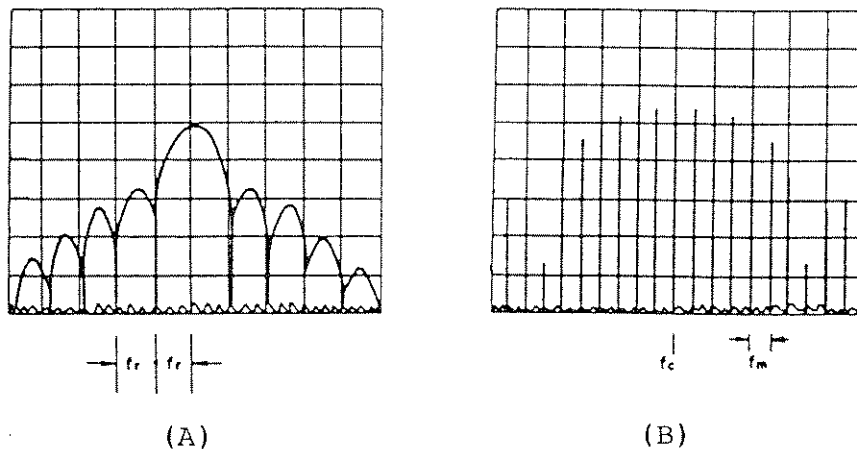

Fig. 6-6 PAM Wave Spectrum Display Examples

6.3 Spurious measurement

Spurious signals measurement can be done with the COUPLED TO REF function, when INPUT ATTEN is suitably set and internal distortion is less than 70 dB. When not using the COUPLED TO REF function, the input signal and the spurious signals generated by the MS610A can be discriminated as follows.

The input signal displayed on the CRT does not change when INPUT ATTEN is changed. (INPUT ATTEN does not affect the value of REF LEVEL, but it automatically changes the IF gain.)

The internal spurious signals due to secondary distortion displayed on the CRT change equal to the amount of change (dB) of INPUT ATTEN, and the internal spurious signals due to tertiary distortion displayed on the CRT change by twice the amount of change (dB) of INPUT ATTEN.

(1) Harmonic distortion measurement

- (a) Since the frequency is often known for this kind of measurement, the instrument is set initially as shown below; the unknown signal spectrum is displayed on the screen.

FREQ COARSE, FINE dials	Tuned to the fundamental wave of the unknown signal.
START FREQ	Set to ON.
COUPLED TO REF	Set to ON.
SPAN (COUPLED TO SPAN)	Set to the FREQ SPAN so that the fundamental wave and harmonics of the unknown signal can be displayed at the same time. However, the sweep time should be speeded up and the span should be made as narrow as possible to allow an easy-to-see display.

Narrower RBW than the specified RBW on COUPLED TO SPAN can be set as follows:

RBW	Set an optimum RBW to measure the unknown spurious signal.
SWEEP T	Set so that DISPLAY UNCAL lamp is not lit.

- (b) The fundamental wave spectrum of the unknown signal is adjusted with REFERENCE LEVEL as shown in Fig. 6-7. When the fundamental wave and harmonics cannot be displayed simultaneously, measure the fundamental wave and the harmonics separately.

Moreover, calculate the distortion of all harmonics from the level difference between the fundamental wave and harmonics.

(2) Inter modulation product measurement

In this case, the screen display shown in Fig. 6-8 is obtained by the display expansion measurement procedure (1) in "Modulated Wave Measurement" 6.2 and the level of each spectrum is measured.

(3) Random spurious signal measurement

Since there are many cases when the frequency and level of spurious signals, such as parasitic oscillation, etc., are unknown, the signal is displayed on the screen and measurement is performed as described in "General Measurement Method" 6.1 (1).

(4) Spectrum purity measurement (sideband noise)

Sideband noise is measured by expanding the spectrum as in the measurement procedure (1) of "Modulated Wave Measurement" 6.2.

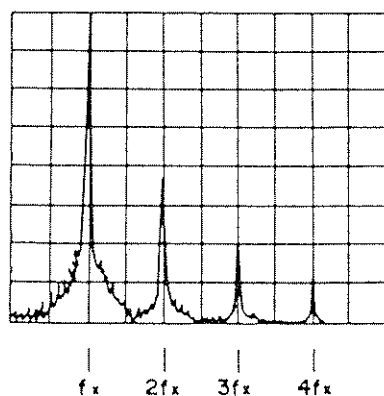

Fig. 6-7 Harmonics Spectrum Display

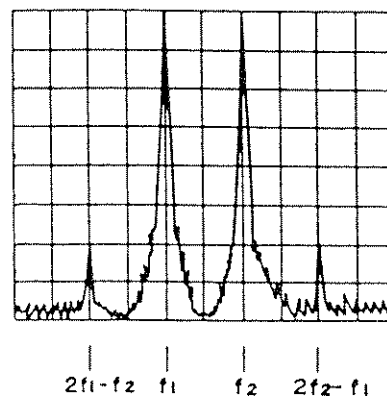

Fig. 6-8 Inter Modulated Wave Spectrum Display

6.4 Field Strength Measurement

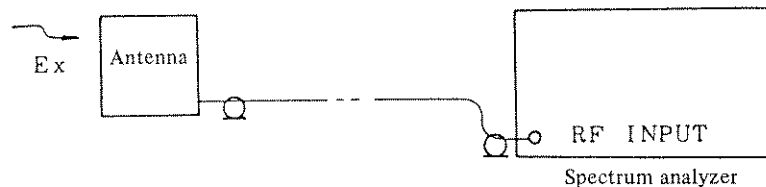

Fig. 6-9 Field Strength Measurement

In field strength measurement, the antenna (application parts) and spectrum analyzer RF INPUT are connected with the connection cable as shown in Fig. 6-9 and an incoming electromagnetic wave is received.

In field strength measurement, the conversion following is necessary. However, if a specified antenna is used, the field strength can be read directly, without compensation.

$$Ex = Px - Ko$$

Px: Measured value

Ko: Antenna coefficient

- (1) Measurement in dB μ units
 - (a) The incoming electromagnetic wave is measured in dB μ units.
 - (b) The field strength is determined from the equation above and from the table supplied with the antenna.
- (2) Direct reading measurement of field strength using the specified antenna
 - (a) The REFERENCE LEVEL knob on the rear panel is set to the position matched to the using specified antenna being used indicated in Table 6-2.

- (b) The incoming electromagnetic wave to be measured is set to the center of the screen with the REFERENCE LEVEL and frequency setting dials in dB μ units.
- (c) The MARKER LEVEL key is set to ON.
- (d) The field strength compensated for by the antenna coefficient for the marker frequency is displayed on the display. The unit is dB μ /m.
- (e) To reduce measurement error, display frequency calibration is necessary. Perform display frequency calibration by using an external oscillator or internal calibration signal output.

(3) Antenna coefficient display

When \wedge of the DATA keys is pressed when the MARKER LEVEL key is set to ON, only the antenna coefficient for the marker frequency is displayed.

To return to the dB μ /m measurement display, press the \vee key.

Table 6-2 Relationship between REFERENCE LEVEL Switch (rear panel) and Antenna

Switch Name	2	3	4
	dB μ /m(1)	dB μ /m(2)	dB μ /m(3)
Antenna Name	MP534A	MP635A	MP636A
Type	Dipole antenna	Log-periodic antenna	Log-periodic antenna
Frequency Range	25 to 520 MHz	80 to 1000 MHz	300 to 1700 MHz

SECTION 7

DAILY MAINTENANCE AND STORAGE

7.1 Daily Maintenance

Daily maintenance of the MS610A consists mainly of cleaning and exterior inspection.

Table 7-1 Daily Maintenance

Problem	Occurrence	Procedure
Outside dirt	Previous to long-term storage.	Wipe with a neutral detergent, etc.
Dust	When used in a dusty place; when dust is noticeable.	Open the cover and blow away the dust with compressed air, etc.
Loosened screws	When found.	Tighten with a screwdriver or other tools.

7.2 Storage

7.2.1 Storage Precautions

Attention should be paid to the items listed below when storing the instrument for an extended period of time.

- (1) Always clean the instrument thoroughly before storage.
- (2) Do not store the instrument under high temperatures (55°C or more), high humidity (90% or more), or excessively low temperatures (-25°C or less).
- (3) Do not store the instrument in direct sunlight or in a dusty place.
- (4) Do not store the instrument in a place where it may be affected by condensation or corrosive gases.

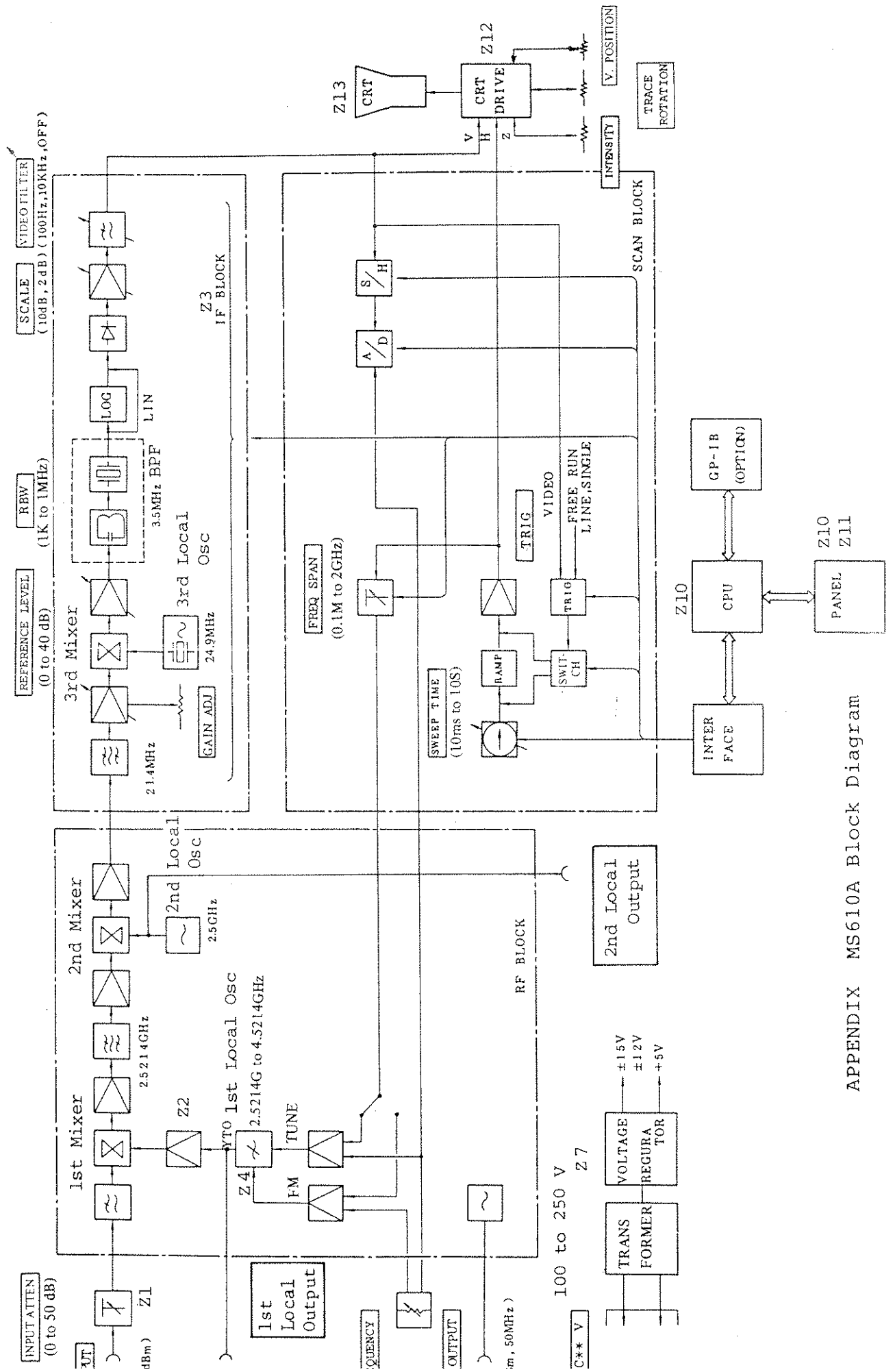

APPENDIX MS610A Block Diagram

7.2.2 Recommended Storage Conditions

In addition to the conditions listed above, the following environmental conditions are recommended when storing the instrument for an extended period of time.

Temperature: 0 to 30°C

Humidity: 40 to 80%

The storage area should not be subject to large fluctuations in temperature and humidity during a 24 hour period.

ANRITSU ELECTRIC CO., LTD.

5-10-27, Minami-azabu, Minato-ku, Tokyo, 106 Japan

Telephone: Tokyo (03)446-1111 Telex: 0-242-2353 ANRITSU J

Cable Address: ANRITDENKI TOKYO